



Electric examination couch
OVALIA V2 range
OV2-09-125

CARINA
Medical



CE
ISO 9001
ISO 13485

TECHNICAL DETAILS

- 2 sections examination couch, width 80cm
- Control : Multifonctionnal hand remote
- Head rest adjustment in every positions with gas jack
- Trendelenburg and anti trendelenburg position in standard
- Flat upholstery with good density 24kg/m², M1 fire retardant class, thickness 5cm
- Frame composed of 2 electronic columns, giving the couch high stability
- Equipped with paper roll holder for exam sheet, on the head side
- Shapped base for ideal cleaning, base colour light grey (RAL 7035)
- On 4 wheels diam. 125mm with one brake on each wheel

DIMENSIONS

- Width 80cm
- Adjustable height from 48 to 88cm
- Load capacity : 200kg in dynamic

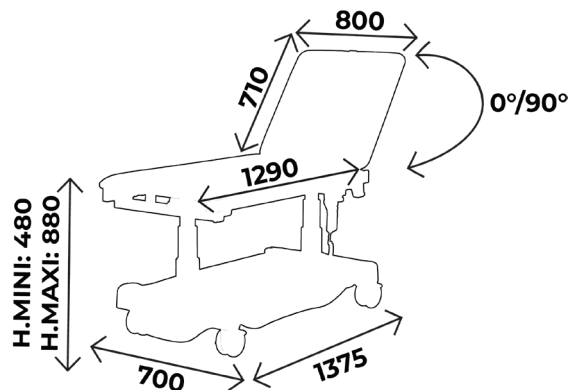

You may also like :

Ref. **OV2-06-125** : Same as OV2-09-125 but width 70cm

Ref. **OV2-08-125** : Same as OV2-09-125 but multifonctionnal hand remote control

Ref. **OV2-05-125** : Same as OV2-09-125 but width 70cm and multifonctionnal hand remote control



WHAT YOU NEED TO KNOW

- ✓ Delivery time: 15 days upon receipt of order
- ✓ Warranty : 5 years (1 year for the upholstery)

ACCESSORIES



RL-150
4 wheels diam. 150mm
with central brake system



ACC 76-OVALIA-80
Pair of clamps
for couch width 80cm



ACC 110POLY
Polyurethane blood test splint
without clamp, the unit



ACC 110
Blood test splint in colour
without clamp, the unit



ACC 964
Pair of legrests on knee system
in black polyurethane,
diam. 14 mm, without clamp

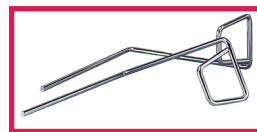

ACC 105
Pair of stainless steel stirrups
diam. 14mm, without clamp



SLFEMIREPOSE
Cover for legrests ACC964
in upholstery, the unit



ACC 514-UNIVERSE
Plastic protection cover
for all couches



ACC 32012
Stainless steel infusion stand
diam. 16mm, 2 plastic hooks,
without clamp



ACC 76C
Unit clamp to fix infusion stand
diam. 16mm



ACC 832
Face hole with plug cushion

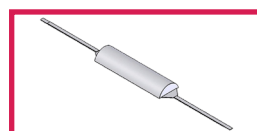

ACC 54003
Half moon headrest width 80cm
fire retardant M1 class



ACC OVALIA06
Hand remote for OVALIA +
connecting cable for double
control



ACC OVALIA05
Pedal for OVALIA + connecting
cable for double control



ACC OVALIA02
Pair of stainless steel rails 25x10
length 1500mm for OVALIA V2
2 sections



ACC BATTERIE01
Battery, capacity 20 cycles
(1 cycle = 1x height's up/ down +
1x backrest's up/ down)



ACC BARRILITOV08
Pair of retractable security side
rails for width 80cm



ACC TETERGO
Ergonomic headrest



ACC-CAPOT
Base colour in a different colour
than the standards light grey
available in different colours

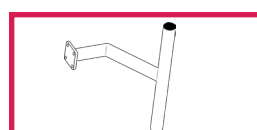

ACC FEMINA01
Coloscope holder

ACC14

Electric jack for backrest for OVALIA V2,
2 sections only

UPHOLSTERY'S COLOURS

Fire retardant
upholstery, M1 class

For the upholstery colours, you can choose between the Classic and Urban range
Be careful ! Urban colours **with extra value**

Upholstery : Classic range



Arno



Garonne



Potomac

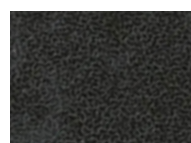

Amour

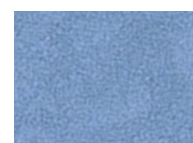

Mississippi



St Laurent



Rhône



Missouri



Seine

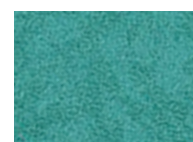

Amazone

Upholstery : Urban range



Abysses



Cendre



Origan

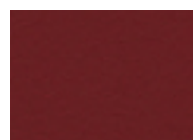

Géranium



Réglisse



Prune

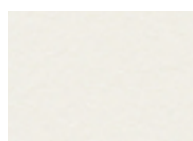

Perle

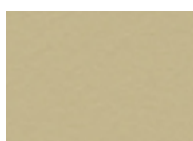

Ficelle

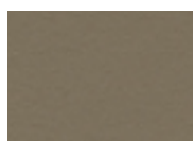

Terre

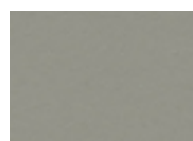

Béton

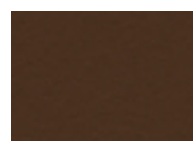

Chataigne



Chocolat



Pensée



Pétrole



Turquoise



Granny



Absinthe



Ananas



Orange



Fuschia



Tomate

BASE COLOURS

The entire OVALIA V2 range has a light grey (RAL 7035) cover as standard
Possibility to change the colour of the cover **with an extra charge (option ACC CAPOT)**

Base colour

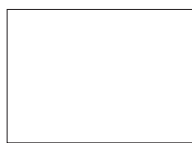

RAL 9003

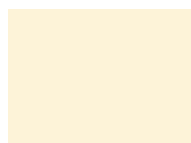

RAL 1013

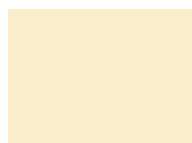

RAL 1015

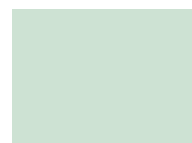

RAL 6019



RAL 6033



RAL 6000



RAL 5017



RAL 5002



RAL 5000



RAL 7035



RAL 7016

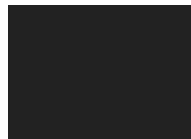

RAL 9005



RAL 1018



RAL 3020



RAL 3003

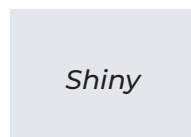

Shiny

SILVER



MAINTENANCE GUIDE

DAILY MAINTENANCE

Upholstery : Cleaning with soapy water only (no solvents), can be disinfected with products such as Phagosept Spray, Salvanios pH10 at 0.75% and Anios Surfaces Hautes, without abrasive material

Base : cleaning with soapy water only (no solvents) without abrasive materials

WARRANTY

Mechanical/ electrical part : 5 years

Upholstery : 1 year



CONTACT

CARINA
Médical

Parc d'entreprises Visionis
278 rue de l'industrie
01090 GUÉREINS- FRANCE

COMMERCIAL DEPARTMENT

Tél : +33(0)4 74 66 69 49
Fax : +33(0)4 74 66 69 50
export@carinamedical.com